

HILTI

DX E-72

| | |
|--------------------------------|-----------|
| Bedienungsanleitung | de |
| Operating instructions | en |
| Mode d'emploi | fr |
| Istruzioni d'uso | it |
| Manual de instrucciones | es |
| Manual de instruções | pt |
| Gebruiksaanwijzing | nl |
| Brugsanvisning | da |
| Bruksanvisning | sv |
| Bruksanvisning | no |
| Käyttöohje | fi |
| 操作说明书 | cn |



1

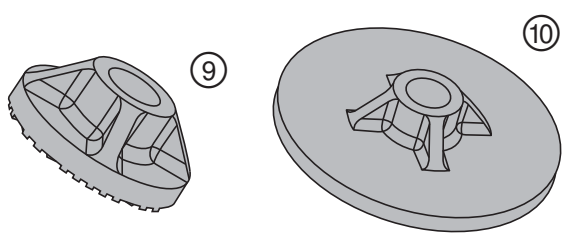
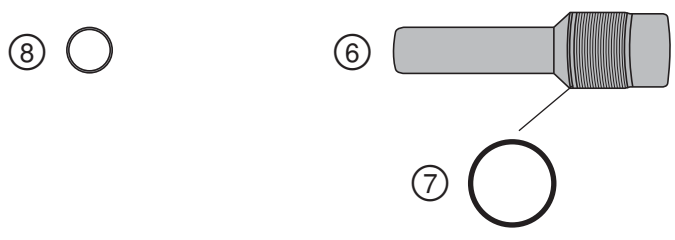
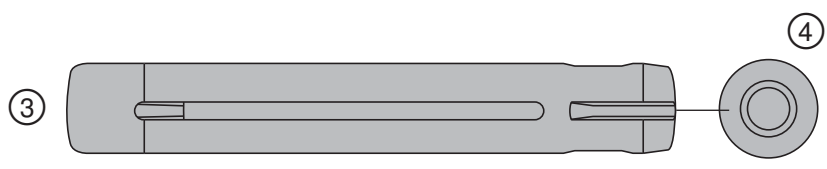
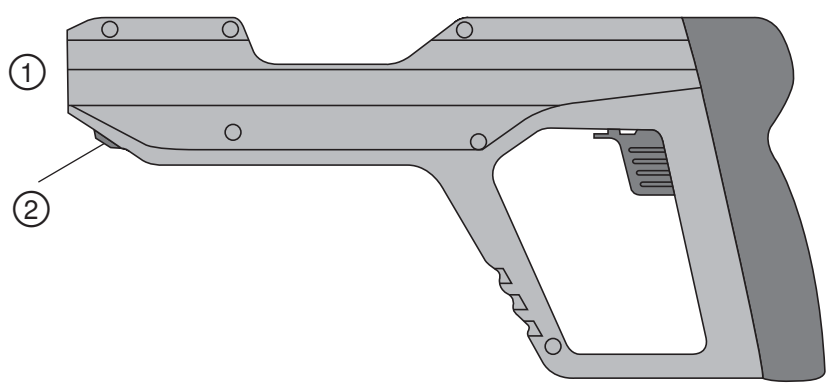

2

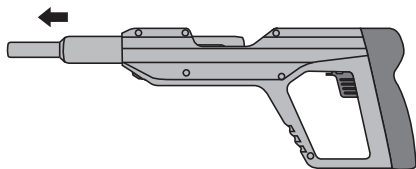

3

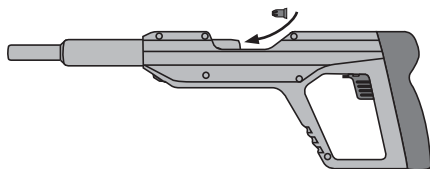

4

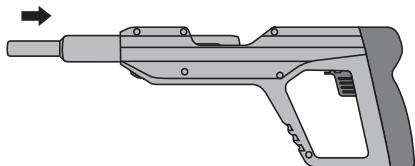

5



6

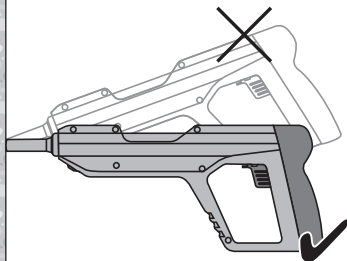

7

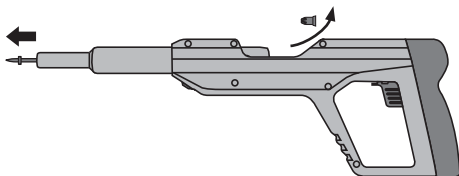

8

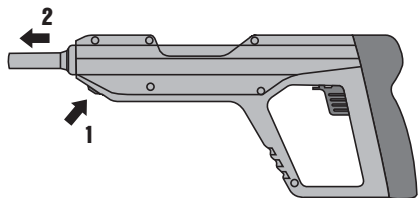

9

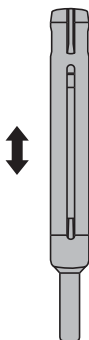

10

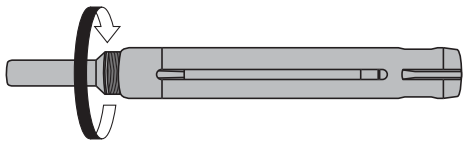

11

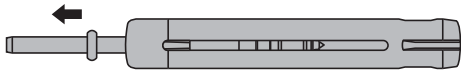

12

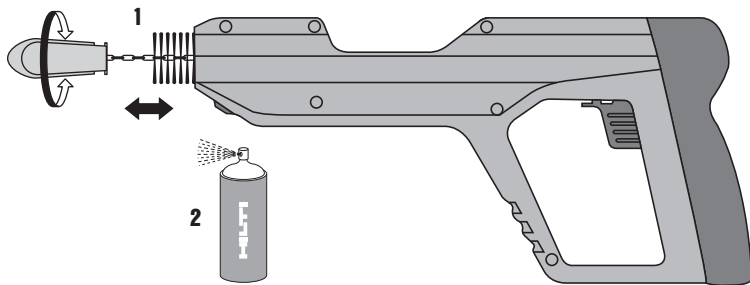

13

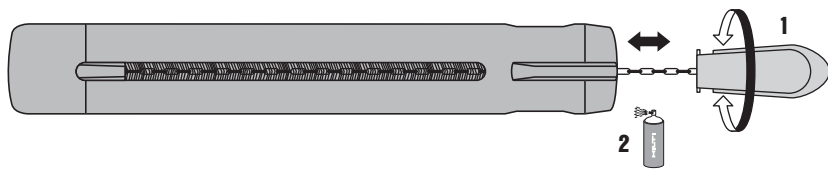

14

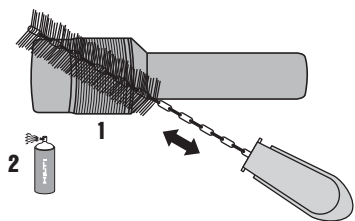

15

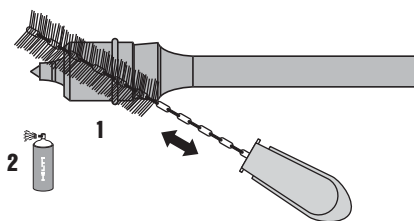

16

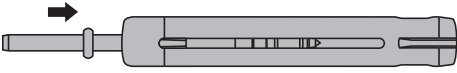

17

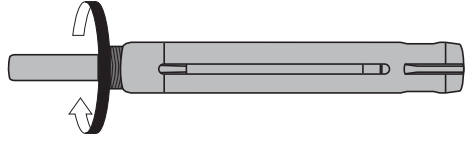

18

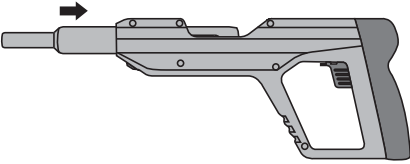

DX E-72 powder-actuated fastening tool

It is essential that the operating instructions are read before the tool is operated for the first time.

Always keep these operating instructions together with the tool.

Ensure that the operating instructions are with the tool when it is given to other persons.

| Contents | Page |
|--|------|
| 1 Safety instructions | 17 |
| 2 General information | 19 |
| 3 Description | 19 |
| 4 Accessories, consumables | 21 |
| 5 Technical data | 22 |
| 6 Before use | 22 |
| 7 Guidelines | 22 |
| 8 Operation | 23 |
| 9 Care and maintenance | 24 |
| 10 Troubleshooting | 26 |
| 11 Disposal | 30 |
| 12 Manufacturer's warranty - tools | 30 |
| 13 EC declaration of conformity (original) | 30 |
| 14 Confirmation of CIP testing | 31 |
| 15 Health and safety of the operator | 31 |

These numbers refer to the corresponding illustrations. The illustrations can be found on the fold-out cover pages. Keep these pages open while studying the operating instructions.

In these operating instructions, the designation "the tool" always refers to the DX E-72 powder-actuated fastening tool.

Parts and operating controls

- ① Casing
- ② Catch
- ③ Piston guide
- ④ Cartridge chamber
- ⑤ Piston
- ⑥ Fastener guide
- ⑦ O-ring
- ⑧ Stop ring
- ⑨ Optional stabilizer (fragmentation guard, only USA)
- ⑩ Optional stabilizer (fragmentation guard, Northern Europe)

1 Safety instructions

1.1 Basic information concerning safety

In addition to the information relevant to safety given in each of the sections of these operating instructions, the following points must be strictly observed at all times.

1.1.1 Using cartridges

Use only Hilti cartridges or cartridges of equivalent quality.

Use of cartridges of inferior quality in Hilti tools may lead to a build-up of unburned powder, which may explode and cause severe injuries to operators and bystanders. Cartridges must fulfill one of the following minimum requirements:

- a) The applicable manufacturer must be able to verify successful testing in accordance with the EU standard EN 16264 or
- b) The cartridges must bear the CE conformity mark (mandatory in the EU as of July 2013).

NOTE

All Hilti cartridges for powder-actuated tools have been tested successfully in accordance with EN 16264. The tests defined in the EN 16264 standard are system tests

carried out by the certification authority using specific combinations of cartridges and tools. The tool designation, the name of the certification authority and the system test number are printed on the cartridge packaging.

Please refer to the packaging example at: www.hilti.com/dx-cartridges

1.1.2 Requirements to be met by users

- a) **The tool is intended for professional use.**
- b) **The tool may be operated, serviced and repaired only by authorized, trained personnel. This personnel must be informed of any special hazards that may be encountered.**

1.1.3 Personal safety

- a) **Stay alert, watch what you are doing and use common sense when operating a direct fastening tool. Don't use the tool when you are tired or under the influence of drugs, alcohol or medication. Stop using the tool if you experience pain or do not feel well. A moment of inattention while operating the tool may result in serious personal injury.**

en

- b) **Avoid unfavorable body positions. Make sure you work from a safe stance and stay in balance at all times.**
- c) **Wear non-skid shoes.**
- d) **Never point the tool toward yourself or other persons.**
- e) **Never press the nosepiece of the tool against your hand or against any other part of your body (or other person's hand or part of their body).**
- f) **Keep other persons, especially children, away from the area in which the work is being carried out.**
- g) **Keep the arms slightly bent while operating the tool (do not straighten the arms).**
- h) **Observe the information printed in the operating instructions concerning operation, care and maintenance.**

1.1.4 Use and care of powder-actuated fastening tools

- a) **Use the right tool for the job. Do not use the tool for purposes for which it was not intended. Use it only as directed and when in faultless condition.**
- b) **Never leave a loaded tool unattended.**
- c) **Store unused cartridges and tools currently not in use in a dry place where they are not exposed to high temperatures.**
- d) **Transport and store the tool in a toolbox that can be secured to prevent unauthorized use.**
- e) **Always unload the tool (remove cartridges and fasteners) before cleaning, before maintenance, before work breaks and before storing the tool.**
- f) **When not in use, tools must be unloaded and stored in a dry place, locked up or out of reach of children.**
- g) **Check the tool and its accessories for any damage. Guards, safety devices and any slightly worn parts must be checked carefully to ensure that they function faultlessly and as intended. Check that moving parts function correctly without sticking and that no parts are damaged. All parts must be fitted correctly and fulfill all conditions necessary for correct operation of the tool. Damaged guards, safety devices and other parts must be repaired or replaced properly at a Hilti service center unless otherwise indicated in the operating instructions.**
- h) **Pull the trigger only when the tool is fully pressed against the working surface at right angles.**
- i) **Always hold the tool securely and at right angles to the working surface when driving in fasteners. This will help to prevent fasteners being deflected by the working surface.**
- j) **Never redrive a fastener. This may cause the fastener to break and the tool may jam.**
- k) **Never drive fasteners into existing holes unless this is recommended by Hilti.**
- l) **Always observe the application guidelines.**
- m) **Use the fragmentation guard (stabilizer) whenever allowed by the application.**
- n) **Never pull the fastener guide back by hand as this could make the tool ready to fire. This could**

cause a fastener or the piston to be driven into a part of the body.

1.1.5 Work area safety



- a) **Ensure that the workplace is well lit.**
- b) **Operate the tool only in well-ventilated working areas.**
- c) **Do not attempt to drive fasteners into unsuitable materials:** Materials that are too hard, e.g. welded steel and cast iron. Materials that are too soft, e.g. wood and drywall panel (gypsum board). Materials that are too brittle, e.g. glass and ceramic tiles. Driving a fastener into these materials may cause the fastener to break, shatter or to be driven right through.
- d) **Never attempt to drive fasteners into materials such as glass, marble, plastic, bronze, brass, copper, rock, insulation material, hollow brick, ceramic brick, thin sheet metal (< 4 mm), cast iron or cellular concrete.**
- e) **Before driving fasteners, check that no one is present immediately behind or below the working surface.**
- f) **Keep the workplace tidy. Objects which could cause injury should be removed from the working area.** Untidiness at the workplace can lead to accidents.
- g) **Keep the grips dry, clean and free from oil and grease.**
- h) **Do not use the tool where there is a risk of fire or explosion unless it has been specially approved for use under these conditions.**

1.1.6 Mechanical safety precautions



- a) **Select the correct fastener guide and fastener combination for the job on hand.** Failure to use the correct combination of these items may result in injury or cause damage to the tool and/or lead to unsatisfactory fastening quality.
- b) **Use only fasteners of a type approved for use with the tool.**
- c) **Do not tamper with or modify the tool or parts of it, especially the piston.**

1.1.7 Thermal safety precautions

- a) **If the tool has overheated, allow it to cool down. Do not exceed the recommended fastener driving rate.**
- b) **If the tool has overheated, allow it to cool down.**
- c) **Do not dismantle the tool while it is hot. Allow the tool to cool down.**

1.1.8 Danger of explosion



- a) Use only cartridges of a type approved for use with the tool.
- b) Never use force when attempting to remove unused cartridges from the tool.

- c) Store unused cartridges in a locked place where they are not exposed to dampness or excessively high temperatures.

1.1.9 Personal protective equipment



The user and any other persons in the vicinity must wear suitable eye protection, a hard hat and ear protection while the tool is in use or when remedying a problem with the tool.

en

2 General information

2.1 Safety notices and their meaning

DANGER

Draws attention to imminent danger that will lead to serious bodily injury or fatality.

WARNING

Draws attention to a potentially dangerous situation that could lead to serious personal injury or fatality.

CAUTION

Draws attention to a potentially dangerous situation that could lead to slight personal injury or damage to the equipment or other property.

NOTE

Draws attention to an instruction or other useful information.

2.2 Explanation of the pictograms and other information

Warning signs



General warning



Warning: explosive substances



Warning: hot surface

Obligation signs



Wear eye protection



Wear a hard hat



Wear ear protection



Read the operating instructions before use.

Location of identification data on the tool

The type designation and serial number can be found on the type identification plate on the tool. Make a note of this data in your operating instructions and always refer to it when making an enquiry to your Hilti representative or service department.

Type: _____

Generation: 01 _____

Serial no.: _____

3 Description

3.1 Use of the product as directed

The tool is designed for professional use in fastening applications where nails, threaded studs and composite fasteners are driven into concrete, steel and sand-lime block masonry.

The tool is for hand-held use only.

Modification of the tool is not permissible.

The tool may not be used in an explosive or flammable atmosphere unless it has been approved for use under these conditions.

To avoid the risk of injury use only genuine Hilti fasteners, cartridges, accessories and spare parts or those of equivalent quality.

Observe the information printed in the operating instructions concerning operation, care and maintenance.

The tool and its ancillary equipment may present hazards when used incorrectly by untrained personnel or when used not as directed.

The tool may be operated, serviced and repaired only by trained personnel. This personnel must be informed of any special hazards that may be encountered.

As with all powder-actuated fastening tools, the tool, cartridges and fasteners form a technical unit. This means that trouble-free fastening with this system can be assured only if the Hilti fasteners and cartridges specially manufactured for it, or products of equivalent quality, are used. The fastening and application recommendations given by Hilti apply only when these conditions are observed.

The tool features a 5-way safety system for the safety of the user and all bystanders.

3.2 Piston principle

The energy from the propellant charge is transferred to a piston, the accelerated mass of which drives the fastener into the base material. Due to use of this piston principle, the tool is classified as a "low velocity tool". As approximately 95% of the kinetic energy is absorbed by the piston, the fastener is driven into the base material in a controlled fashion at much reduced velocity (less than 100 m/s). The driving process ends when the piston is stopped at the end of its travel. This makes dangerous through-shots virtually impossible when the tool is used correctly.

3.3 Drop-firing safety device

The drop-firing safety device is the result of coupling the firing mechanism with the cocking movement. This prevents the tool from firing when dropped onto a hard surface, no matter at which angle the impact occurs.

3.4 Trigger safety device

The trigger safety device prevents the tool firing when only the trigger is pulled. The tool must be pressed against a firm surface before a fastener can be released.

3.5 Contact pressure safety device

The tool can be fired only when pressed fully against a firm surface with a force of at least 50 N.

3.6 Unintentional firing safety device

The tool is also equipped with an unintentional firing safety device. This prevents the tool from firing if the trigger is first pulled and the tool then pressed against the work surface. The tool can be fired only when it is first pressed correctly against the work surface and the trigger subsequently pulled.

3.7 Range of fasteners available for various applications

Fasteners

| Ordering designation | Application |
|----------------------|---|
| X-U | High-strength nail for fastening on high-strength steel and concrete in a wide range of applications |
| X-C | Standard nail for fastening on concrete |
| X-S | Standard nail for efficient fastening on steel |
| X-CT | Easily removable nail for fastening formwork temporarily on concrete |
| X-CR | Stainless steel nail for fastening in damp or corrosive surroundings |
| X-CP / X-CF | Special fastener for timber structures on concrete |
| X-FS | Fastener for positioning formwork |
| X-SW | Flexible washer fastener for fastening plastic sheeting and thin insulating materials to concrete and steel |
| X-HS / X-HS-W | Suspension system with threaded connection |
| X-CC | Fastening clip for wire hangers |

| Ordering designation | Application |
|----------------------|---|
| X-(D)FB / X-EMTC | Metal conduit clip for fastening electrical conduits or insulated pipes (hot or cold) in water supply and heating installations |
| X-EKB | Cable clasp for fastening electric cables flat on ceilings and walls |
| X-ECH | Bunched cable holder for fastening cables on ceilings and walls |
| X-ET | Fastener for plastic (PVC) electric cable trunking |
| X-(E)M/W/6/8 ... P8 | Threaded stud for temporary fastenings on concrete and steel |
| X-DNH / DKH X-M6/8H | Approved (ETA) DX-Kwik fastening system use on concrete with predrilling |

Cartridges

| Ordering designation | Color | Power level |
|----------------------|--------|-------------|
| 5.6/16 brown | Brown | Extra-light |
| 5.6/16 green | Green | Light |
| 5.6/16 yellow | Yellow | Medium |
| 5.6/16 red | Red | Heavy |

4 Accessories, consumables

NOTE

For information about further accessories and fasteners for use with the tool, please contact your local Hilti representative.

| Designation | Item number, description |
|--|--------------------------|
| Piston guide | 1005, E72 |
| Piston | 409314, 72/DNI |
| Fastener guide | 1086, E72/F1 |
| O-ring | 72475 |
| Stop ring | 1095 |
| Optional stabilizer (fragmentation guard, only USA) | 1089 |
| Optional stabilizer (fragmentation guard, Northern Europe) | 1191 |

Safety accessories and cleaning set

| Designation |
|---|
| Cleaning set |
| Hilti spray |
| Operating instructions |
| Stabilizer (only for USA and Northern Europe) |

5 Technical data

Right of technical changes reserved.

| Tool | DX E-72 |
|-------------------------------------|--|
| Weight | 2.0 kg |
| Dimensions (L x W x H) | 384 mm x 48 mm x 153 mm |
| Maximum fastener length | 72 mm |
| Cartridges | 5.6/16 (22 cal. short) brown, green, yellow, red |
| Power regulation | 4 cartridge power levels |
| Contact movement | 16 mm |
| Contact pressure | 100 N |
| Ambient operating temperature range | -15...+50°C |
| Recommended maximum fastening rate | 250/h |

6 Before use



NOTE

Read the operating instructions before the tool is operated for the first time.

6.1 Check the tool

WARNING

Do not operate the tool when parts are damaged or when the controls do not function correctly. If necessary, have the tool repaired at an authorized Hilti service center.

Check that there is no cartridge in the tool. If there is a cartridge in the tool, remove it from the tool by hand.

Check all external parts of the tool for damage and check that all controls operate faultlessly.

Check the piston and stop ring for wear and ensure that the parts have been fitted correctly.

7 Guidelines

7.1 Fastening guidelines

These guidelines must be observed at all times.

NOTE

For detailed information, please ask your local Hilti sales and service office for a copy of the applicable technical guidelines or national technical regulations.

7.1.1 Minimum distances and spacing

Minimum distances and spacing when fastening to steel

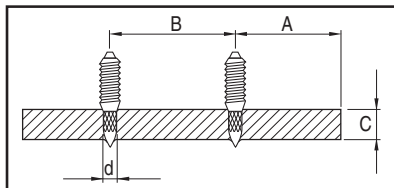

A min. edge distance = 15 mm ($\frac{5}{8}$ ")

B min. spacing = 20 mm ($\frac{3}{4}$ ")

C min. base material thickness = 4 mm ($\frac{5}{32}$ ")

Minimum distances and spacing when fastening to concrete

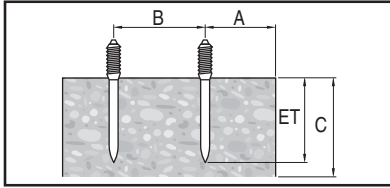

A min. edge distance = 70 mm (2¾")

b min. spacing = 80 mm (3⅛")

c min. base material thickness = 100 mm (4")

7.1.2 Depth of penetration

NOTE

Examples and specific information can be found in the Hilti Fastening Technology Manual.

Nail lengths for steel

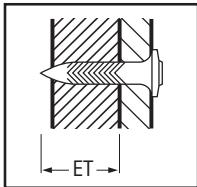

ET Depth of penetration: 12 ± 2 mm (½" ± ⅛")

Nail lengths for concrete

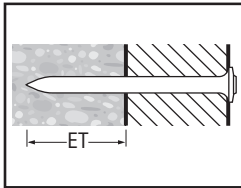

ET Depth of penetration: 22 mm (max. 27 mm) (7/8" (max. 1"))

8 Operation



WARNING

Driving a fastener may cause flying fragments. **The user of the tool and bystanders must wear protective glasses and a hard hat.** Flying fragments present a risk of injury to the eyes and body.

CAUTION

The fastener driving action is initiated by ignition of a propellant charge. **The operator and bystanders must wear ear protectors.** Exposure to noise can cause hearing loss.

WARNING

Never make the tool ready to fire by pressing it against a part of the body (e.g. the hand). This could cause a nail or the piston to be driven into a part of the body. **Never press the tool against a part of the body.**

WARNING

Never redrive a fastener. This may cause the fastener to break and the tool may jam.

WARNING

Never drive fasteners into existing holes unless this is recommended by Hilti (e.g. DX-Kwik).

CAUTION

If the tool has overheated, allow it to cool down. Do not exceed the recommended fastener driving rate.

8.1 Procedure if a cartridge fails to fire

If a cartridge fails to fire or misfires, always proceed as follows:

Keep the nose of the tool pressed at right angles against the working surface for 30 seconds.

If the cartridge still fails to fire, withdraw the tool from the working surface, taking care to avoid pointing it toward your body or toward bystanders.

Remove the cartridge and dispose of it appropriately, i.e. in a way that rules out further use or misuse.

8.2 Loading the tool 2 3 4 5

The tool must be cycled and loaded before driving each fastener.

1. Grip the fastener guide between the thumb and forefinger and pull it forward in the main axis of the tool as far as it will go.
2. Insert an unused cartridge in the cartridge chamber.
NOTE Insert the cartridge in the tool gently. Do not press it in!
3. Then pull the fastener guide all the way back to its original position.
This movement returns the piston to its original position, ready to drive a fastener.
4. Push the nail, head first, into the nose of the tool from the front until it is held in place in the tool by the washer on the nail.
NOTE If the cycling action (i.e. pulling out, pushing back in) is stiff, this indicates that the tool needs to be cleaned. Service the tool! see section 9.3
The tool is then ready to drive the next fastener.

8.3 Setting the power level

1. Select the cartridge power level according to the application to be carried out.

2. If you cannot estimate this on the basis of previous experience, always begin with the lowest power. Select the lowest power level according to the color code.
3. Drive a nail.
If the nail does not penetrate deeply enough, use a more powerful cartridge.

8.4 Driving a fastener 6

WARNING

Always observe the safety rules listed in the operating instructions.

1. Press the tool against the working surface at right angles.
2. Drive the fastener by pulling the trigger.

8.5 Unloading the tool 7

WARNING

Never attempt to remove a cartridge from the cartridge chamber by prying it out from behind with a pointed or sharp object.

As soon as you have finished the work, check to ensure that there is no cartridge or nail in the tool. If the tool is still loaded after finishing the work, remove the cartridge and the nail from the tool.

NOTE

If a cartridge case remains stuck in the cartridge chamber, disassemble the tool as described in section 9.3.1 and use the ramrod to push the cartridge case out of the cartridge chamber from the front.

9 Care and maintenance



CAUTION

When this type of tool is used under normal operating conditions, dirt and residues build up inside the tool and functionally relevant parts are also subject to wear. **Regular inspections and maintenance are thus essential in order to ensure reliable operation. We recommend that the tool is cleaned and the condition of the piston checked at least daily when the tool is subjected to intensive use, and at the latest after driving 3,000 fasteners.**

WARNING

Make sure there is no cartridge in the tool before carrying out maintenance or repairs. Make sure there is no fastener in the fastener guide.

CAUTION

The tool may get hot during use. You could burn your hands. **Do not dismantle the tool while it is hot. Allow the tool to cool down.**

9.1 Care of the tool

WARNING

Do not use a spray or steam/water jet system for cleaning. Never operate the tool when the ventilation slots are blocked. Do not permit foreign objects to enter the interior of the tool.

Clean the outside of the tool at regular intervals with a slightly damp cloth.

9.2 Maintenance

Check all external parts of the tool for damage at regular intervals and check that all controls operate faultlessly. Do not operate the tool if parts are damaged or when the controls do not function faultlessly. If necessary, the tool should be repaired by Hilti Service.

Use the tool only with the recommended cartridges. Use of the wrong cartridges or use of excessively high power settings may lead to premature failure of parts of the tool.

WARNING

Dirt and residues in DX tools contain substances that may be hazardous to your health. **Do not inhale dust / or dirt from cleaning. Keep the dust or dirt away from foodstuffs. Wash your hands after cleaning the tool.**

Never use grease for the maintenance/lubrication of parts of the tool. This may lead to malfunctions. Use only Hilti lubricant spray or a product of equivalent quality.

9.3 Servicing the tool

Service the tool if fastener driving power is found to be inconsistent, if cartridges misfire or if parts of the tool no longer move or operate smoothly and easily. In other words, the contact pressure required to make the tool ready to fire increases, trigger resistance increases, used cartridges are difficult to remove or the cycling action becomes stiff.

9.3.1 Disassembling the tool 8 9 10 11

NOTE

If the tool is badly fouled, push the piston out of the piston guide by pushing it from behind, through the cartridge chamber. Use the ramrod for this purpose.

1. Press the catch fully and, at the same time, pull the assembly vertically right out of the tool.
2. Tap the assembly lightly on the floor to bring the piston forward.
3. Hold the fastener guide securely with one hand and turn the piston guide counterclockwise with the other hand.
4. Remove the stop ring and pull the piston out.

9.3.2 Checking the piston and stop ring for damage or wear

NOTE

Never use a worn or damaged piston and do not tamper with or attempt to modify the piston.

NOTE

Replace the stop ring if it is deformed or damaged.

CAUTION

Continued use of the tool with a deformed stop ring may result in damage to the fastener guide and piston.

Replace the piston if:

- the piston is broken
- the piston is badly worn or chipped (e.g. a 90° segment broken away).
- the piston ring is cracked or missing.
- the piston is bent (check by rolling the piston on a smooth, flat surface).

9.3.3 Checking the fastener guide for wear

Replace the fastener guide if the tubular section is damaged (e.g. bent, widened or cracked).

9.3.4 Checking the O-ring for damage or wear

Replace the O-ring if it is cracked, badly squashed or missing.

9.3.5 Cleaning 12 13 14 15

CAUTION

Take care to avoid damaging the O-ring with the brush.

Clean the tool at least once a week or, respectively, immediately after each period of heavy use (after driving approx. 3,000 nails).

Use the appropriate brushes to clean the individual parts:

- clean the inside of the housing
- clean the piston guide and the cartridge chamber
- clean the inside and the outside of the fastener guide

Clean the piston and the piston ring until it moves freely.

9.3.6 Lubrication

Spray the cleaned parts lightly with the Hilti lubricant spray supplied. Use only Hilti lubricant spray or a product of comparable quality.

9.3.7 Assembling the tool 16 17 18

NOTE

Handle the small parts carefully. They could get lost.

1. Fit the stop ring to the piston and then push the piston into the piston guide.
2. Screw the fastener guide into the piston guide until flush.
3. Push the assembly, with the slot underneath, into the tool as far as it will go.

9.3.8 Checking

After carrying out care and maintenance, check that all protective and safety devices are fitted and that they function faultlessly.

NOTE

The tool can be checked, as follows, to determine whether it is ready to fire: Press the nose of the unloaded tool (i.e. no cartridges or fastener in the tool) firmly against a hard surface and pull the trigger. A clearly heard click from the trigger mechanism indicates that the tool was ready to fire.

10 Troubleshooting

WARNING

The tool must be unloaded before taking any steps to remedy faults.

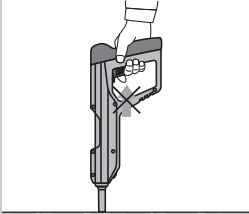
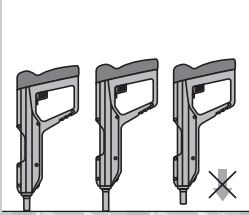
| Fault | Possible cause | Remedy |
|--|--|--|
| Higher force required to cycle the tool. | Build-up of combustion residues. | Service the tool. See section: 9.3 Servicing the tool |
| Higher force required to press the tool against the surface. | Build-up of combustion residues. | Service the tool. See section: 9.3 Servicing the tool |
| Trigger resistance increases. | Build-up of combustion residues. | Service the tool. See section: 9.3 Servicing the tool |
| The tool cannot be cycled. | The stop ring is damaged. | Change the stop ring. |
| | Driving power is too high. The piston jams as a result. | Release the jammed piston. Use a less powerful cartridge or a longer nail. |
| | No fastener inserted. The piston jams as a result. | Release the jammed piston. Load a nail. |
| | The tool is fouled with combustion residues. | Clean the tool. If the problem persists, service the tool. WARNING Never use force when attempting to remove unused cartridges from the tool. See section: 9.3 Servicing the tool |
| The tool cannot be fired. |  <p>The tool was not pressed fully against the working surface. Bad cartridge.</p> | Press the tool fully against the working surface. |
| | | Use a new cartridge. |
| The tool is not cycled. | The tool is fouled with combustion residues. | Clean the tool. If the problem persists, service the tool. WARNING Never use force when attempting to remove unused cartridges from the tool. See section: 9.3 Servicing the tool |
| | The tool is not cycled. | Cycle the tool. |
| Tool jams. |  | The tool needs to be cleaned. |
| | | The piston is damaged. |
| | The tool is damaged. | If the problem persists, contact your local Hilti Center. |

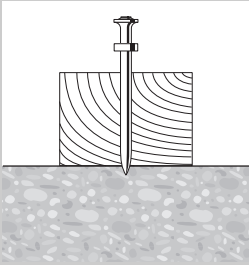
| Fault | Possible cause | Remedy |
|---|---|---|
| <p>Misfire: The fastener is only partly driven into the base material.</p>  | <p>The piston was in the wrong position.</p> <p>The tool is cycled unevenly, sometimes not fully.</p> <p>The piston ring is defective or missing.</p> <p>Bad cartridges.</p> <p>The tool is fouled with combustion residues.</p> <p>The tool is not cycled.</p> | <p>Cycle the tool. See section: 8.5 Unloading the tool 7</p> <p>Cycle the tool fully.</p> <p>Change the piston.</p> <p>Change the cartridges (use a different / dry package if necessary). If the problem persists: service the tool. See section: 9.3 Servicing the tool</p> <p>Clean the tool. If the problem persists, service the tool. WARNING Never use force when attempting to remove unused cartridges from the tool. See section: 9.3 Servicing the tool</p> <p>Cycle the tool.</p> |
| <p>The cartridge is not ejected when the tool is cycled.</p> | <p>Driving power is too high. The piston jams as a result.</p> <p>No fastener inserted. The piston jams as a result.</p> <p>The tool has overheated.</p> <p>The tool is damaged.</p> | <p>Release the jammed piston. Use a less powerful cartridge or a longer nail.</p> <p>Release the jammed piston. Load fastener(s) into the tool.</p> <p>Allow the tool to cool down. Subsequently remove the cartridge case carefully from the tool. WARNING Never use force when attempting to remove unused cartridges from the tool.</p> <p>Contact Hilti.</p> |
| <p>The cartridge case cannot be removed.</p> | <p>The cartridge case is deformed.</p> | <p>Disassemble the tool and remove the sticking cartridge case from the cartridge chamber by pushing from the front with the ramrod. WARNING Never use force when attempting to remove unused cartridges from the tool. See section: 9.3.1 Disassembling the tool 8 9 10 11</p> |

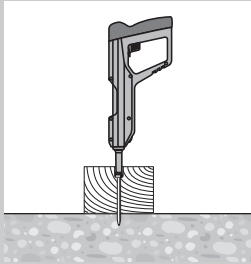
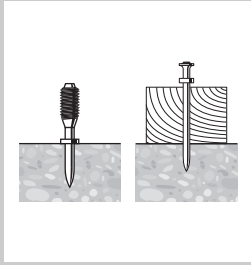
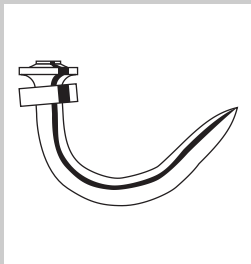
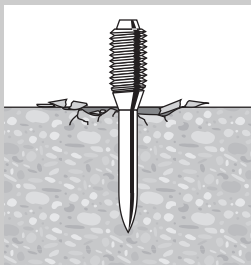
| Fault | Possible cause | Remedy |
|--|---|--|
| The piston gets stuck in the base material / fastener is driven too deeply. | The fastener is too short. | Use a longer fastener. |
|  | The fastener has no washer. | Use a fastener with washer for applications on wood. |
| | Driving power is too high. | Use a less powerful cartridge. |
| | The fastener is not driven deeply enough. | The fastener is too long. |
|  | Driving power is too low. | Use a more powerful cartridge. |
| | The nail bends. | Hard surface or hard and/or large aggregates in the concrete. |
|  | A rebar is located just below the concrete surface. | Use a shorter nail. Use a nail with a higher application limit. Use the DX-Kwik method (predrilling). Drive the fastener at a different position. |
| | Concrete spalling. | Hard/old concrete. |
|  | Hard surface or hard and/or large aggregates in the concrete. | Use a more powerful cartridge. Use the DX-Kwik method (predrilling). |

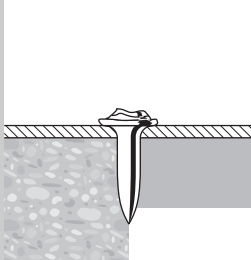
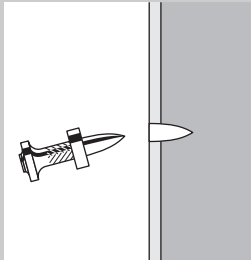
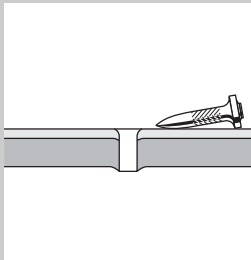
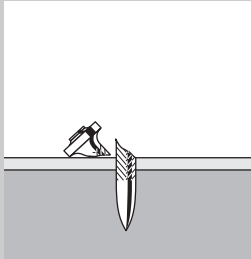
| Fault | Possible cause | Remedy |
|---|---|---|
| <p data-bbox="82 132 250 153">Damaged nail head.</p>  | <p data-bbox="374 132 586 153">Driving power is too high.</p> <hr/> <p data-bbox="374 228 684 268">Application limit exceeded (very hard material).</p> <hr/> <p data-bbox="374 339 568 360">The piston is defective.</p> | <p data-bbox="714 132 964 153">Use a less powerful cartridge.</p> <hr/> <p data-bbox="714 228 1009 268">Use a nail with a higher application limit.</p> <hr/> <p data-bbox="714 339 874 360">Change the piston.</p> |
| <p data-bbox="82 435 303 475">The nail doesn't penetrate deeply enough.</p>  | <p data-bbox="374 435 583 456">Driving power is too low.</p> <hr/> <p data-bbox="374 528 684 568">Application limit exceeded (very hard material).</p> <hr/> <p data-bbox="374 639 586 660">The system is unsuitable.</p> | <p data-bbox="714 435 975 456">Use a more powerful cartridge.</p> <hr/> <p data-bbox="714 528 1009 568">Use a nail with a higher application limit.</p> <hr/> <p data-bbox="714 639 997 679">Use a more powerful system, e.g. DX 76 (PTR).</p> |
| <p data-bbox="82 754 311 794">The nail doesn't hold in the base material.</p>  | <p data-bbox="374 754 650 775">Thin steel base material (< 4 mm)</p> | <p data-bbox="714 754 1023 815">Use a different cartridge. Use a nail suitable for thin steel base material.</p> |
| <p data-bbox="82 1074 202 1094">Nail breakage.</p>  | <p data-bbox="374 1074 583 1094">Driving power is too low.</p> <hr/> <p data-bbox="374 1134 684 1174">Application limit exceeded (very hard material).</p> | <p data-bbox="714 1074 975 1094">Use a more powerful cartridge.</p> <hr/> <p data-bbox="714 1134 1009 1198">Use a shorter nail. Use a nail with a higher application limit.</p> <p data-bbox="714 1206 1009 1334">NOTE Observe the min. fastener driving depth requirements. Ask you local Hilti sales and service office for a copy of the Hilti Fastening Technology Manual.</p> |

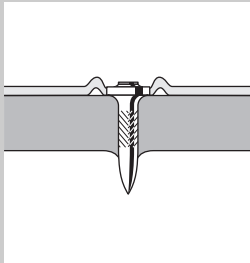
| Fault | Possible cause | Remedy |
|--|----------------------------|---|
| The head of the nail punches through the material fastened (sheet metal). | Driving power is too high. | Use a less powerful cartridge. Use a nail with a "top hat". Use a nail with a washer. |
|  | | |

11 Disposal



Most of the materials from which Hilti tools or appliances are manufactured can be recycled. The materials must be correctly separated before they can be recycled. In many countries, Hilti has already made arrangements for taking back old tools and appliances for recycling. Ask Hilti customer service or your Hilti representative for further information.

12 Manufacturer's warranty - tools

Please contact your local Hilti representative if you have questions about the warranty conditions.

13 EC declaration of conformity (original)

| | |
|-----------------|--------------------------------|
| Designation: | Powder-actuated fastening tool |
| Type: | DX E-72 |
| Generation: | 01 |
| Year of design: | 1991 |

We declare, on our sole responsibility, that this product complies with the following directives and standards: 2006/42/EC, 2011/65/EU.

**Hilti Corporation, Feldkircherstrasse 100,
FL-9494 Schaan**



Norbert Wohlwend
Head of Quality & Processes Management
BU Direct Fastening
04/2013



Tassilo Deinzer
Head BU Measuring Systems
BU Measuring Systems
04/2013

Technical documentation filed at:

Hilti Entwicklungsgesellschaft mbH
Zulassung Elektrowerkzeuge
Hiltistrasse 6
86916 Kaufering
Deutschland

14 Confirmation of CIP testing

The following applies to C.I.P. member states outside the EU and EFTA judicial area: The Hilti DX E-72 has been system and type tested. As a result, the tool bears the rectangular PTB approval mark showing approval number S 832. Hilti thus guarantees compliance with the

approved type. Unacceptable defects or deficiencies, etc. determined during use of the tool must be reported to the person responsible at the approval authority (PTB) and to the Office of the Permanent International Commission (C.I.P.).

15 Health and safety of the operator

15.1 Noise information

Powder-actuated fastening tool

| | |
|------------------|--|
| Type | DX E-72 |
| Model | Series |
| Caliber | 5.6/16 yellow |
| Power regulation | The tool has no power regulation feature. |
| Application | Fastening 20 mm laminated wood to concrete (C40) with the X-U47 P8 |

Declared measured values of noise characteristics according to 2006/42/EC Machinery Directive in conjunction with DIN EN 15895

| | |
|---|------------|
| Noise (power) level, $L_{WA}, 1s$ ¹ | 115 dB (A) |
| Emission noise-pressure level in the work station, $L_{pA}, 1s$ ² | 107 dB (A) |
| Peak sound pressure emission level, $L_{pC, peak}$ ³ | 141 dB (C) |
| ¹ ± 2 dB (A) ² ± 2 dB (A) ³ ± 2 dB (C) | |

Operation and set-up conditions: Set-up and operation of the pin driver in accordance with E DIN EN 15895-1 in the semi-anechoic test room of Müller-BBM GmbH. The ambient conditions in the test room conform to DIN EN ISO 3745.

Testing procedure: Enveloping surface method in anechoic room on reflective surface area in accordance with E DIN EN 15895, DIN EN ISO 3745 and DIN EN ISO 11201.

NOTE The noise emissions measured and the associated measurement uncertainty represent the upper limit for the noise values to be expected during the measurements.

Variations in operating conditions may cause deviations from these emission values.

15.2 Vibration

Total vibration in accordance with 2006/42/EC does not exceed 2.5 m/s².

Further information about user health and safety can be found at www.hilti.com/hse.



Hilti Corporation

LI-9494 Schaan

Tel.: +423 / 234 21 11

Fax: +423 / 234 29 65

www.hilti.com

Hilti = registered trademark of Hilti Corp., Schaan

W 4031 | 0414 | 00-Pos. 1 | 1

Printed in China © 2014

Right of technical and programme changes reserved S. E. & O.

2021512 / A4

